

**March 22, 2020**

**REVISED**

**COVID-19  
Emergency Response and Telecommuting**

On March 19, 2020, the State of California and the County of Los Angeles effected a “Stay at Home” order due to COVID-19. Accordingly, most Employees throughout the College, except those whose services were deemed critical to operations during the state of emergency, are directed to not report to work beginning March 20, 2020, until further notice. Employees will remain in a paid status during this emergency closure. The College recognizes future local, state, and federal government directives may necessitate further changes in working conditions, and additional emergency actions may need to be taken by the College President in support of public and employee health. Standard College business hours during this period of COVID-19 Emergency Response Telecommuting Plan will be 8:00 a.m. – 4:30 p.m., Monday through Friday.

Employees may be transitioned to an Emergency COVID-19 Telecommuting Plan on March 23, 2020, or thereafter, at the discretion of the College. Departments or units shall provide a business plan for approval to the appropriate Vice President before Employees are permitted to telecommute.

Employees will be permitted to telecommute as a temporary measure only and will be reviewed continuously during the period in which the College encourages social distancing as a measure intended to minimize the spread of the current health situation. The College may alter this schedule or end the temporary telecommuting agreement at any time in its sole discretion.

- A. All existing duties, obligations, responsibilities, and conditions of employment remain unchanged. Telecommuting employees are expected to abide by rules and regulations, Collective Bargaining Agreements, and College Board Policies and Administrative Procedures.
- B. Telecommuting employees are required to perform their assigned work duties and be accessible as if they are working at their College worksite during the established telecommuting Work Schedule. Employees must be accessible at all times during their temporary telecommute scheduled work times via the manner and technology designated by their immediate manager, which may include laptop computer, mobile phone, email, messaging application, video conferencing, instant messaging and/or text messaging. Employees will make themselves available to physically or virtually attend scheduled work meetings, trainings, and other department or unit activities as requested or required by the department or unit.
- C. While temporarily telecommuting, Employee will maintain professionalism, productivity, performance, communication, timeliness of assignments, and responsiveness standards as if Employee were not temporarily telecommuting. Employee remains obligated to comply with all College Board Policies and Administrative Procedures.

- D. Employee may not deviate from their assigned work schedule and is required to take rest and meal breaks while telecommuting in full compliance with their collective bargaining agreement. Employee is prohibited from working additional hours outside of their temporary telecommute work schedule and is expressly prohibited from working overtime without prior approval from their immediate manager. Employee is required to notify their immediate manager within one business day of any failure to take a scheduled rest or meal break, or any work performed outside of the established temporary telecommute schedule.
- E. Employee is solely responsible for the configuration of and all of the expenses associated with establishing and maintaining a telecommuting workspace and related telecommunications services, including network costs, workspace furniture, energy or data charges, unless the Department or unit expressly agrees otherwise in advance of Employee incurring the cost. Employees may contact the help desk for assistance in setting up and/or configuring any personal technology for the purpose of telecommuting.
- F. Employee telecommuting will be solely responsible to create and maintain a safe, ergonomically appropriate, and healthy work environment. If the Employee has concerns about the appropriateness of their workspace, then the Employee and their immediate manager will work with Human Resources through the interactive process to evaluate the needs for accommodations or adjustment of the work assignment.
- G. The College shall not be liable for damages to the Employee's personal or real property during the course of performance of official duties or while using College equipment in the Employee's residence or other property, except where required by law.
- H. The College shall not be responsible for operating expenses, home or property maintenance, or any other incidental costs (e.g., utilities) associated with telecommuting. Employee shall continue to be entitled to reimbursement for authorized travel and expenses while conducting business as assigned by the College per the College's reimbursement policies.
- I. All injuries incurred by Employee during hours that Employee is working, and all illnesses that are job-related must be reported promptly pursuant to Administrative Procedures 7343 - Industrial Accident and Illness. Additional information concerning the College's workers compensation program and process is available can be provided to you by contacting Duetta Langevin, Director, Risk Management via email [dlangevin@mtsac.edu](mailto:dlangevin@mtsac.edu) or Andie Solorzano, Risk Management Specialist via email at [asolorzano14@mtsac.edu](mailto:asolorzano14@mtsac.edu). You may also find additional information on the risk management website at [www.mtsac.edu/risk](http://www.mtsac.edu/risk).
- J. Employee will continue to abide by practices, policies, and procedures for requesting sick, vacation, and other leaves of absence.
- K. If Employee requires access to secure on campus resources; Employee is required to utilize an IT approved and provided solution to do so. This may mean they need a campus provided device or a specific process from their home device. Any campus issued device

must be returned within ten (10) business days of the conclusion of telecommuting agreement.

If Employee will use a personal mobile device or personal desktop while telecommuting, Employee must consult with their manager as well as the College's Information Technology staff to ensure appropriate set up of the personal device(s). Employee is prohibited from tampering with any software, firmware or hardware provided by the College or loaded onto Employee's personal devices to enable Employee to perform College work. Nothing in this section shall abrogate an Employee's right to privacy regarding their personal data and/or telecommunications contained on personal devices or transmitted therein.

- L. Regardless of whether using personal or College-owned devices for College work while telecommuting, Employee is responsible at all times for the access, use and security of those devices. The Employee shall comply with all College Board Policies and Administrative Procedures and standards for safeguarding and protecting any confidential business information, personally identifiable information (PII), and any other sensitive information. The Employee shall ensure that confidential, personally-identifiable, and all other sensitive information discussed via any form of communication is conducted in a manner consistent with College policies and procedures and which protects the information from unauthorized disclosure to the maximum extent possible. All work-related correspondence sent and received must be done via an Employee's @mtsac.edu email address. The immediate manager and Employee will discuss the safeguards and protections in place to be used by the Employee. Employee bears no liability for circumstances beyond their control so long as they are acting in good faith and following established policies and procedures related to information security.

Employee must be sure to connect mobile devices from a secured network, one that requires a username and password. Employees unsure of their setup meets these specifications should contact the IT Help Desk for assistance. Employee must take reasonable precautions to prevent third parties from accessing or handling sensitive and confidential information they access while telecommuting. Employee agrees to close or secure all connections to College desktop or system resources (i.e., remote desktop, virtual private network connections, etc.) when not conducting work for the College. Approval to use non-College issued mobile devices can be revoked at any time.

- M. Employee shall comply with all Board Policies and Administrative Procedures in connection with Employee's telecommuting arrangement, including, but not limited to (<https://www.mtsac.edu/governance/trustees/apbp/index.html>):

1. BP 3050: Institutional Code of Ethics
2. BP 3410: Nondiscrimination
3. BP 3420: Equal Opportunity
4. BP 3430: Probation of Harassment
5. BP 3720: Computer Use

6. BP 6520: Security for College Property
  7. AP 3720: Computer and Network Use
  8. AP 3721: Information Security
  9. Ergonomics Instructions (attached)
  10. Workspace Set up Instructions (attached)
- N. Employee acknowledges and understands that management may at any time adjust or end the temporary telecommuting arrangement. Management will attempt to provide at least 48 hours' advance notice of any changes to the temporary telecommuting arrangement.
- O. Employee agrees to notify the Department or unit in writing within three calendar days of any changes to location from which Employee will be temporarily telecommuting, along with the effective date(s) and duration of such change. Employee understands the College will rely on this information in determining its compliance with any local laws and ordinances while Employee is temporarily telecommuting.
- P. Employees must acknowledge this Telecommuting Agreement via an email confirmation to their immediate manager.

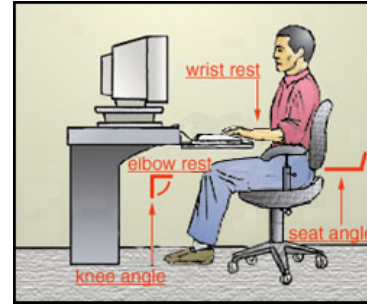

## Setting Up Your Workstation To Fit You!

1. **Chair.** Office chairs are designed to provide seated support for employees working at the computer workstation. A good chair can provide comfort and support for the body. A properly adjusted chair can reduce fatigue by supporting the back, legs, and arms.

✓ **Adjust Properly** –

- **Height:** Correct chair height is when your feet are resting flat on the floor or a footrest, and the back of the knee is slightly higher than the seat of the chair. This will allow the blood in the legs to circulate freely.
- **Backrest:** The backrest should support the entire back comfortably. The rounded, curved section of the backrest should be adjusted to support your waistline or “belt” line. The backrest should be close enough to support your back during all desk activities.
- **Armrests (Optional):** The armrests should be adjusted high enough so the forearms rest lightly on them. If they are too low, you will find yourself slouching or leaning to one side in order to reach them. If they are too high, you will find yourself working with your shoulders elevated.

2. **Keyboard.** Keyboards either sit on top of the desk surface or on a pull-out keyboard platform. A good rule of thumb to remember when working at the keyboard is to keep your elbows level with the spacebar of the keyboard, with the elbows resting comfortably at your side. This allows you to work with your wrists in a straight, neutral position and your shoulders relaxed.

✓ **Adjust Properly** –

- **Keyboard:** Make sure the keyboard legs are flat. Keyboards should be flat on the desktop or pull-out keyboard tray or angled negatively with the back side slightly lower than the front.
- **Wrist rest:** This provides a soft place to rest on and helps to keep the wrists straight. **Remember to use only during pauses from keying.**

3. **Mouse.** Most computers have a mouse. Overuse of the mouse can cause fatigue. Remember that keyboard commands are a very effective alternative for excessive mouse usage.

✓ **Use Properly** –

- Ensure that the mouse is properly placed close to the body.
- Don't over-grip the mouse. Use a relaxed hold.
- When using the mouse, don't just move the wrist! Move the entire arm to move the mouse around.
- Program the mouse to help with common functions.
- Use pull-down menus and keyboard commands to reduce mouse usage.

4. **Monitor.** Monitors are usually placed where space allows. Many people shove their monitors into a corner so they can have increased desk space. This can create problems.

✓ **Adjust Properly** –

- **Location:** The monitor should be placed *directly in front of you!* Posture follows vision. If the monitor is in the corner, you will twist your neck and head to view the monitor. This is not a good posture to hold eight hours a day.
- **Distance:** The monitor should be at the correct viewing distance. Generally, it should be placed out 18 to 24 inches, or about an arm's distance away. If you find yourself leaning forward to read the monitor, it is too far away. Pull it closer.
- **Height:** For normal vision, typically the top of the monitor screen should be AT eye level. The top of the monitor screen should never be above eye level. If it is, it forces you to look up and places the neck into an awkward position. If your monitor is flat on the desktop and angled up, it may be too low, which pulls your posture forward. With the monitor angled up, it can catch too much glare which can create eyestrain.

**NOTE:** Bifocal users may have trouble if the monitor is too high as they will tilt their head back and lift their chin up to view the screen through the bottom portion of the glasses. One recommendation for bifocal users is to lower the monitor flat onto the desktop and angle it down a bit until it is easily read through the bottom portion of the glasses.

- **Glare:** Place the computer set up perpendicular to the window. Shield outside sources of light with blinds, curtains, or window tinting.

✓ **Article Link:** [http://www.osha.gov/SLTC/computerworkstations\\_ecat/index.html](http://www.osha.gov/SLTC/computerworkstations_ecat/index.html)

# Workspace ergonomics

- Always maintain a neutral position
- Items on your workstation should be placed within a reasonable parameter of your workspace

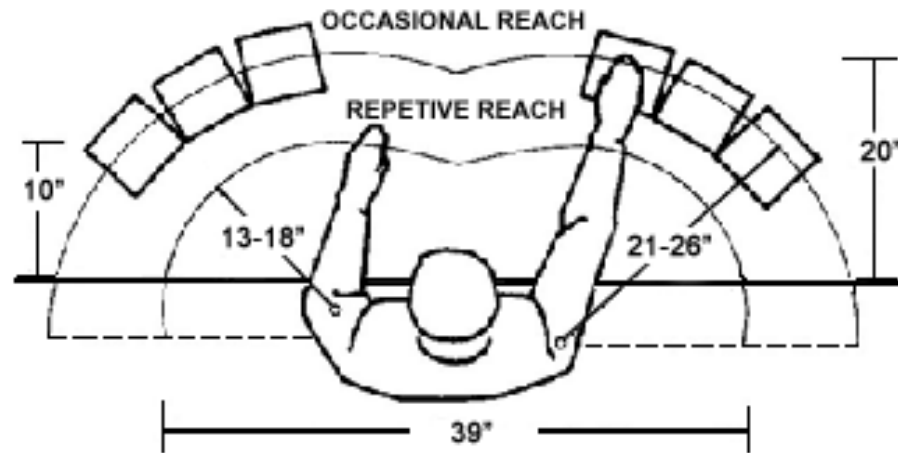

# Office Ergonomics - workstation

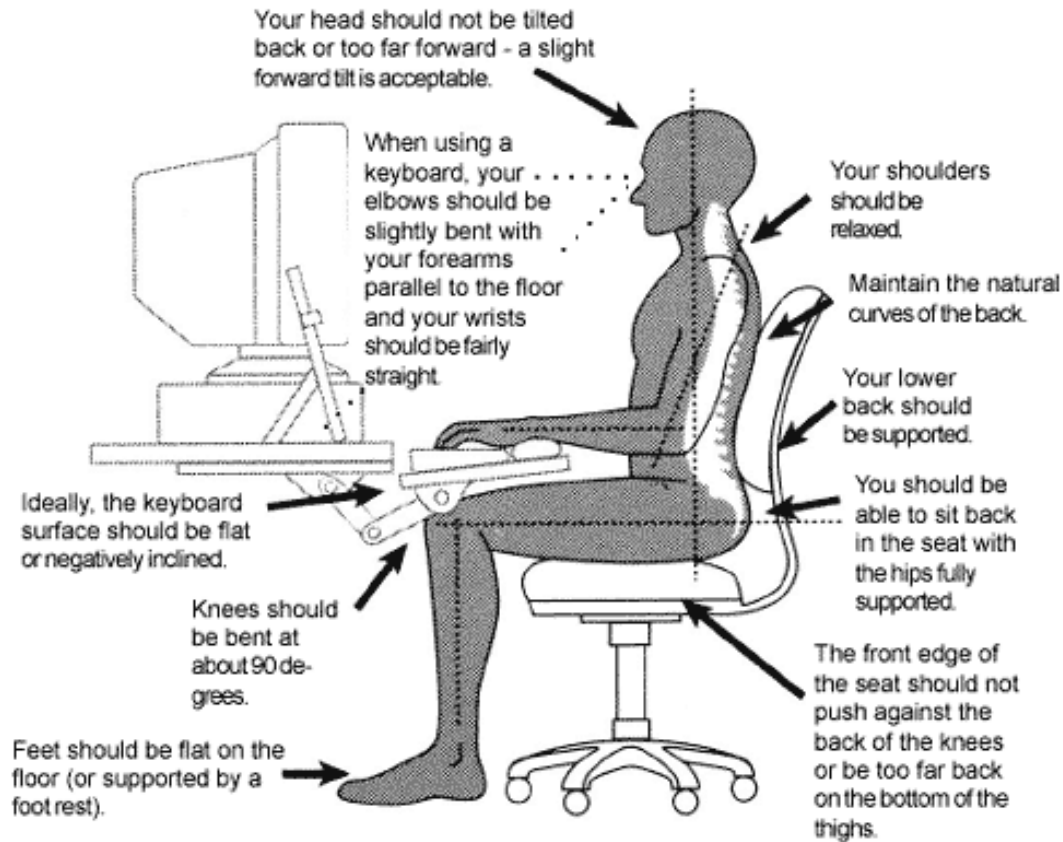



# Office ergonomics – standing workstation

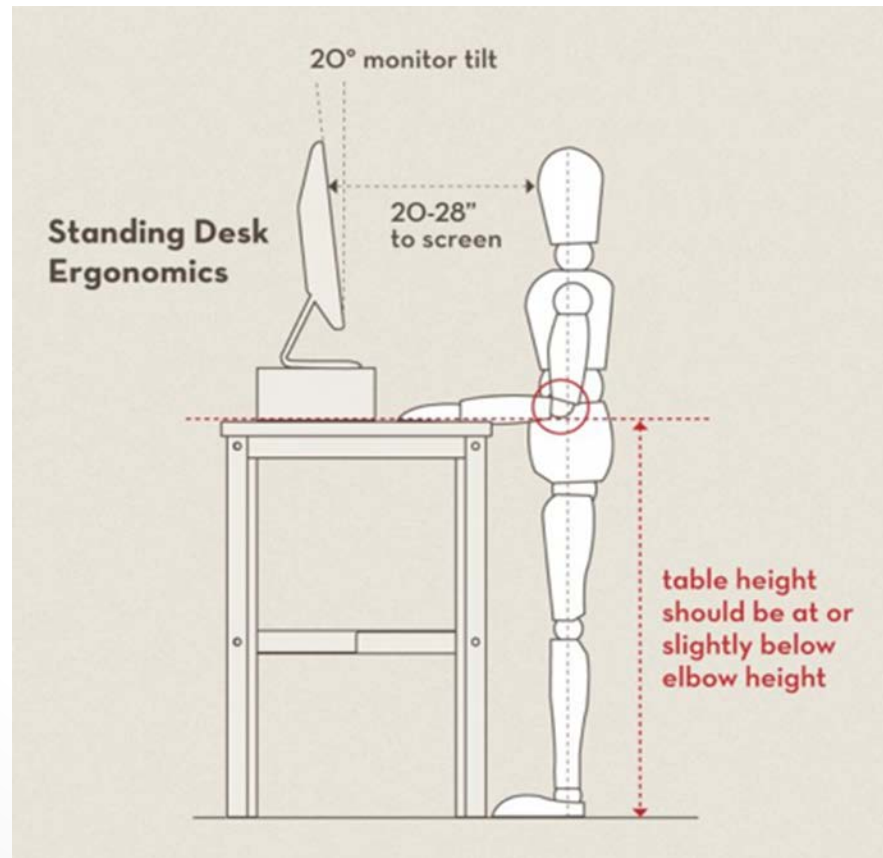

# Office ergonomics - keyboard

**RIGHT!**



**RIGHT!**

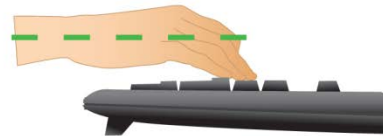

**WRONG!**



**WRONG!**



# Office ergonomics - mouse



**INCORRECT**

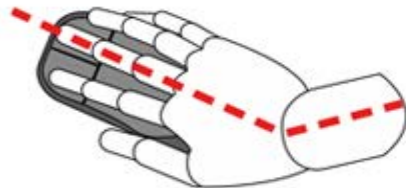
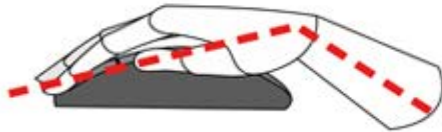

**INCORRECT**

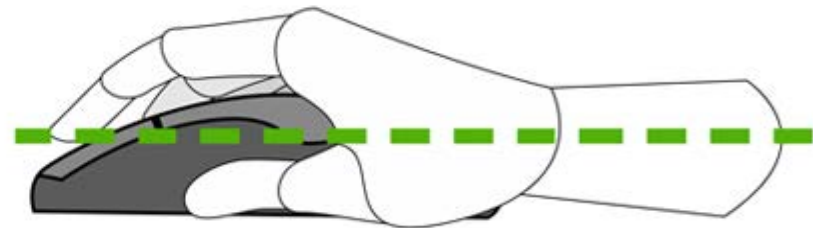
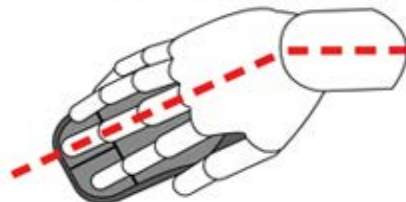

**CORRECT**

